



Equipment Rails

Technical Product Information

ER-3A & ER-3B Styles

P.O. NUMBER _____

CUSTOMER _____

PROJECT _____

LOCATION _____

ARCHITECT _____

STANDARD CONSTRUCTION

- 18 GAUGE GALVANIZED STEEL
- GALVANIZED CAP FLASHING
- WOOD NAILER
 - "A" STYLE FLUSH
 - "B" STYLE _____ OVERHANG
- UNITIZED CONSTRUCTION
- INTERNAL REINFORCEMENT
- CONTINUOUS WELDED CORNER SEAMS

NOTE: STANDARD LUMBER OVERHANG 1/2" UNLESS SPECIFIED OTHERWISE

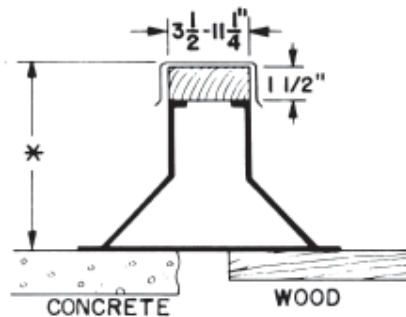

ER-3A STYLE

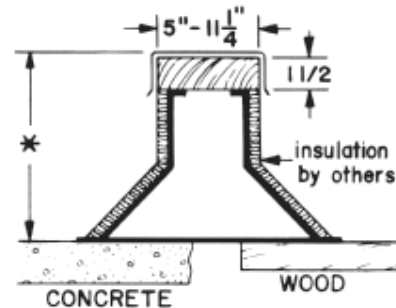

ER-3B STYLE

* NOTE: STANDARD OVERALL HEIGHT 8" UNLESS SPECIFICALLY SHOWN BELOW

PROJECT REQUIREMENTS

QTY.	STYLE	LENGTH	WIDTH	* OVERALL HEIGHT	"B" STYLE NAILER OVERHANG	PITCH REQUIREMENTS		TAG
						LONG SIDE	SHORT SIDE	