



Carnes Roof Curbs

Technical Product Information

CURB O.D. 72-1/2" x 72-1/2"

P.O. NUMBER _____

CUSTOMER _____

PROJECT _____

LOCATION _____

ARCHITECT _____

STANDARD CONSTRUCTION

- 18 GAUGE GALVANIZED STEEL
- 1-1/2", 3LB. DENSITY FIBERGLASS INSULATION
- WOOD NAILER FLUSH
- UNITIZED CONSTRUCTION
- CONTINUOUS WELDED CORNER SEAMS

FITS

- 66 x 66 GI
- 66 x 66 GE
- 66 x 66 GL

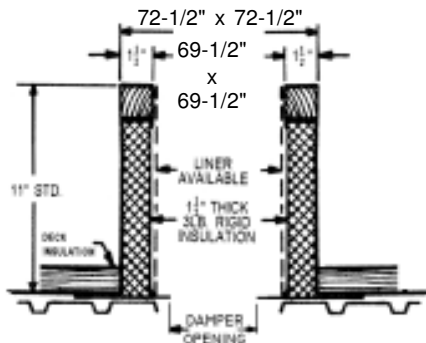

RC-2A

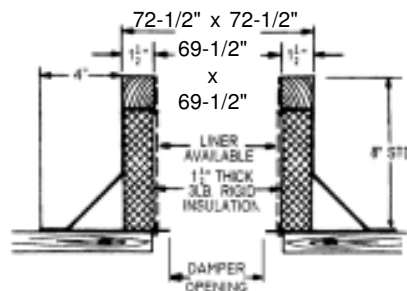

RC-3A

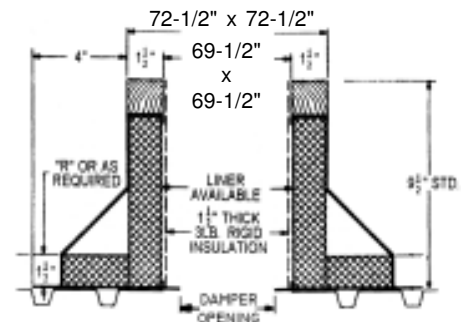

RC-4A

PROJECT REQUIREMENTS

| QTY. | STYLE | * OVERALL HEIGHT | "R" DIM. | PITCH REQUIREMENTS | | DAMPER OPENING | TAG |
|------|-------|------------------|----------|--------------------|------------|----------------|-----|
| | | | | LONG SIDE | SHORT SIDE | | |
| | | | | | | | |