



# Carnes Roof Curbs

Technical Product Information

**CURB O.D. 30-1/2" x 36-1/2"**

P.O. NUMBER \_\_\_\_\_

CUSTOMER \_\_\_\_\_

PROJECT \_\_\_\_\_

LOCATION \_\_\_\_\_

ARCHITECT \_\_\_\_\_

## STANDARD CONSTRUCTION

- 18 GAUGE GALVANIZED STEEL
- 1-1/2", 3LB. DENSITY FIBERGLASS INSULATION
- WOOD NAILER FLUSH
- UNITIZED CONSTRUCTION
- CONTINUOUS WELDED CORNER SEAMS

## FITS

- 24 x 30 GI
- 24 x 30 GE
- 24 x 30 GL

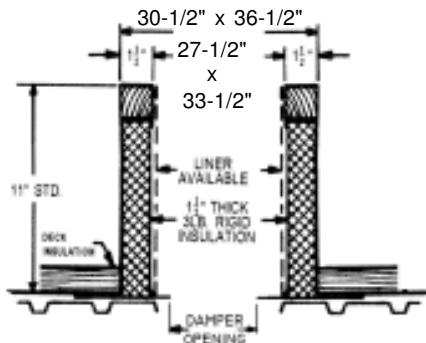

**RC-2A**

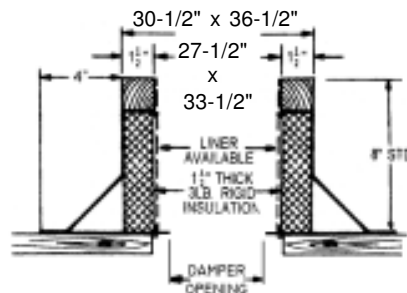

**RC-3A**

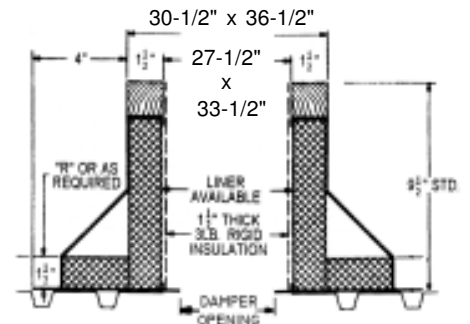

**RC-4A**

## PROJECT REQUIREMENTS

QTY.	STYLE	* OVERALL HEIGHT	"R" DIM.	PITCH REQUIREMENTS		DAMPER OPENING	TAG
				LONG SIDE	SHORT SIDE		