



Carnes Roof Curbs

Technical Product Information

CURB O.D. 26-1/2" x 66-1/2"

P.O. NUMBER _____

CUSTOMER _____

PROJECT _____

LOCATION _____

ARCHITECT _____

STANDARD CONSTRUCTION

- 18 GAUGE GALVANIZED STEEL
- 1-1/2", 3LB. DENSITY FIBERGLASS INSULATION
- WOOD NAILER FLUSH
- UNITIZED CONSTRUCTION
- CONTINUOUS WELDED CORNER SEAMS

FITS

- 20 x 60 GI
- 20 x 60 GE
- 20 x 60 GL

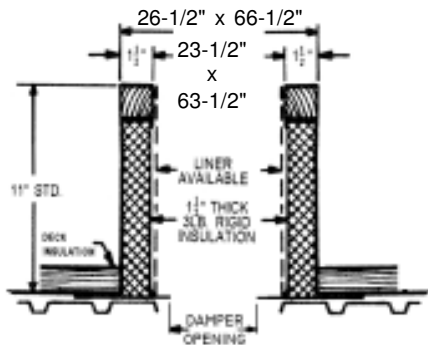

RC-2A

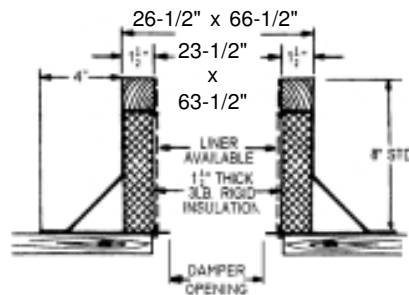

RC-3A

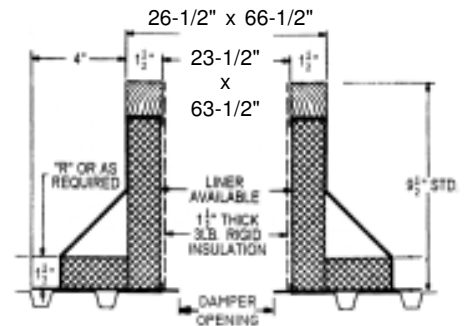

RC-4A

PROJECT REQUIREMENTS

QTY.	STYLE	* OVERALL HEIGHT	"R" DIM.	PITCH REQUIREMENTS		DAMPER OPENING	TAG
				LONG SIDE	SHORT SIDE		